

FOOTING DETAIL-1 (18'x18')

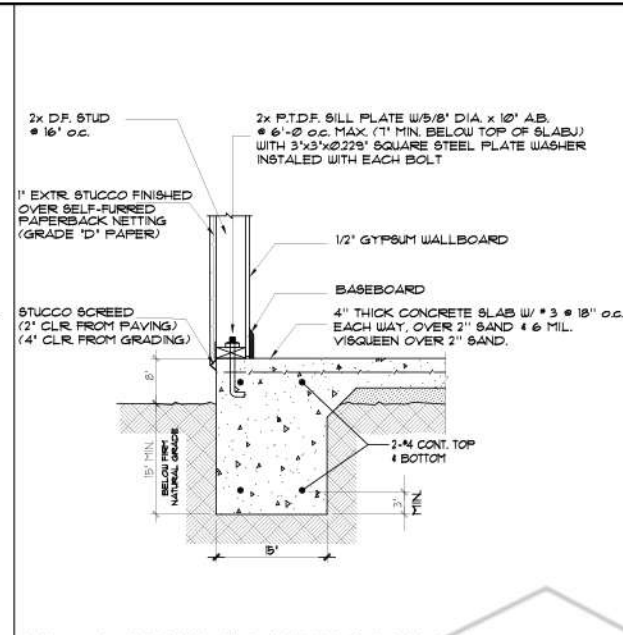

FOOTING DETAIL-2 (18'x18')

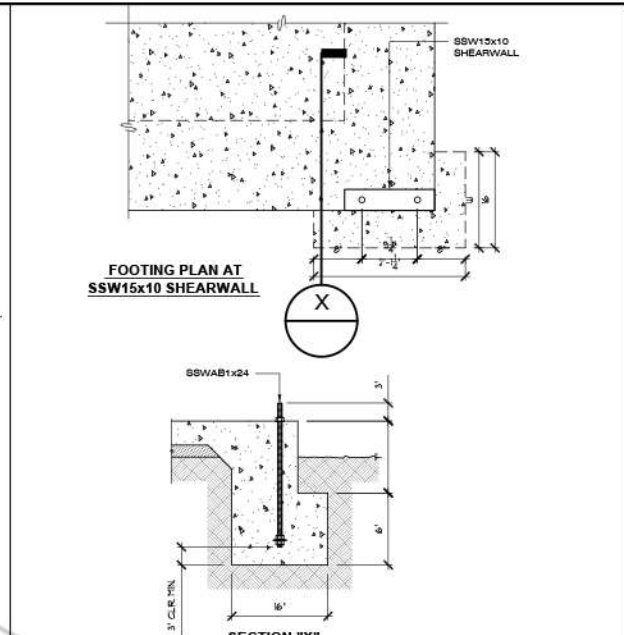

STEEL STRONG-WALL FOUNDATION DETAIL

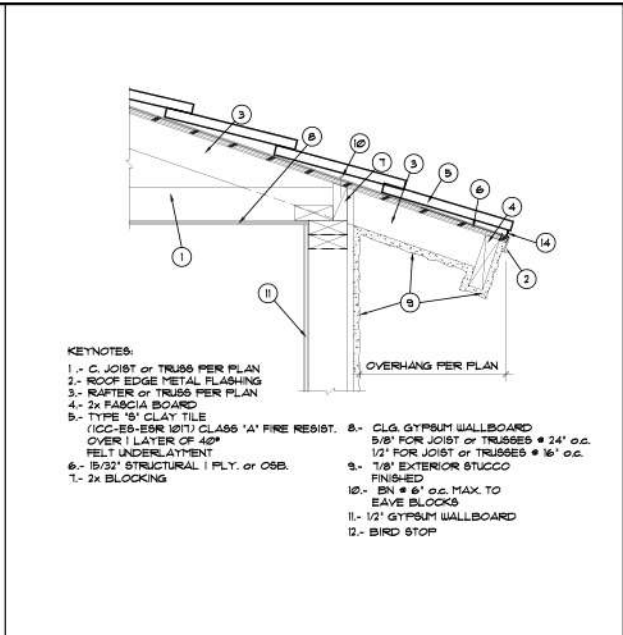

ENHANCED EAVE DETAIL

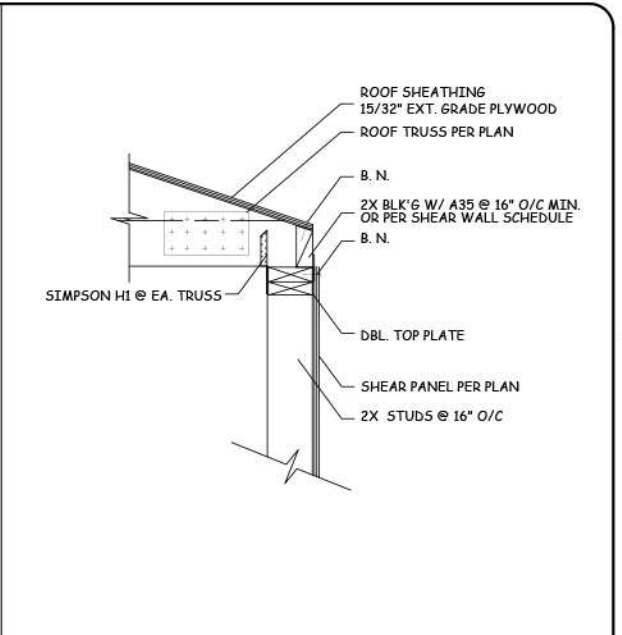

SHEAR TRANSFER AT EAVE DETAIL

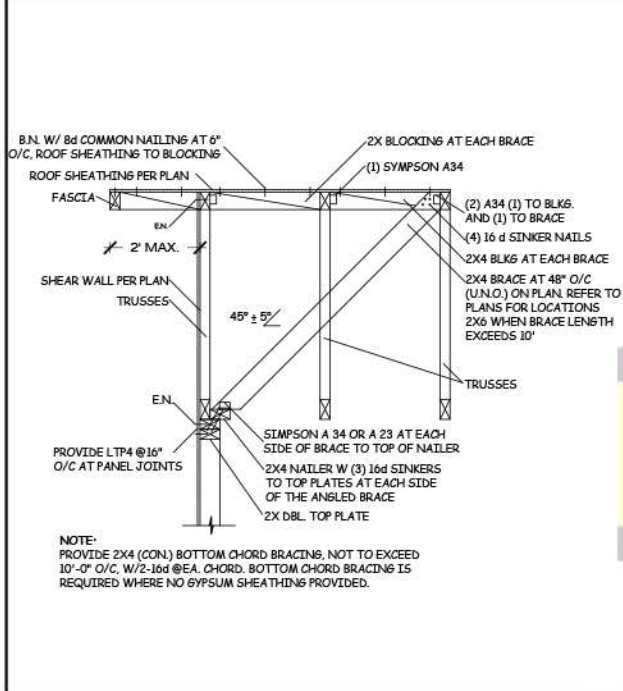

GABLE END TRUSS & SHEARWALL CONNECTION DETAIL

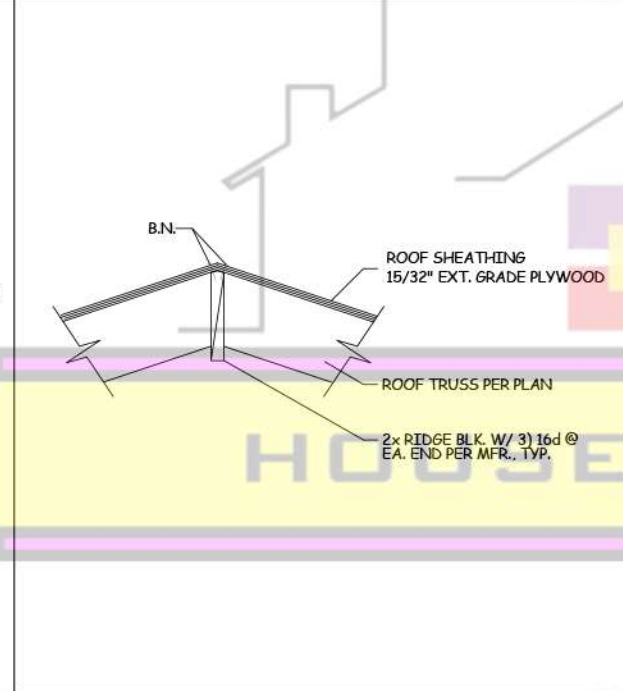

RIDGE FRAMING DETAIL

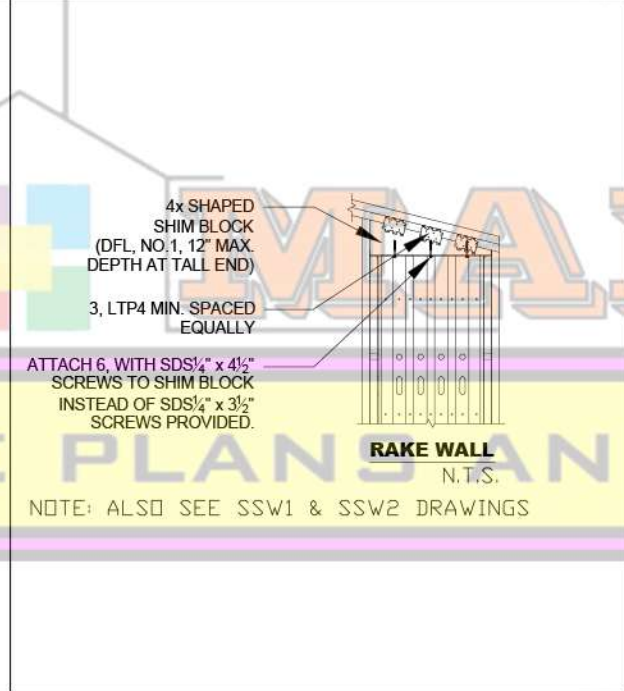

SHEAR TRANSFER @ SSW-RAKE WALL

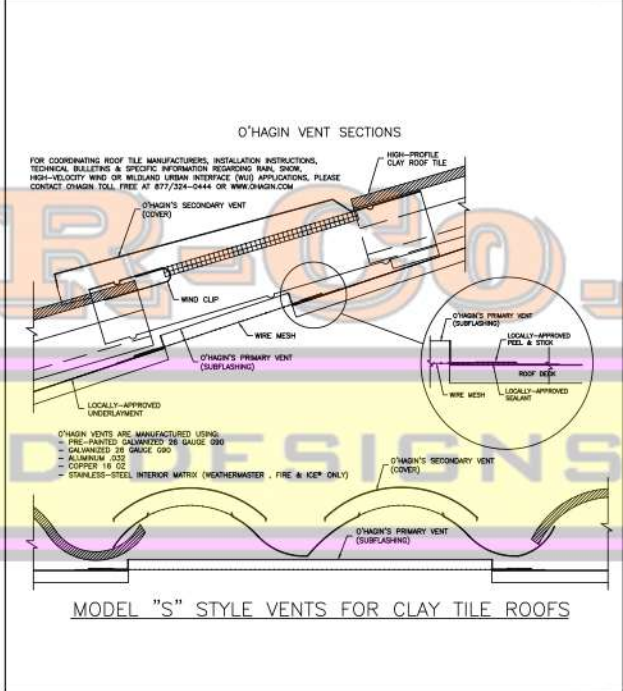

MODEL 'S' STYLE VENTS FOR CLAY TILE ROOFS

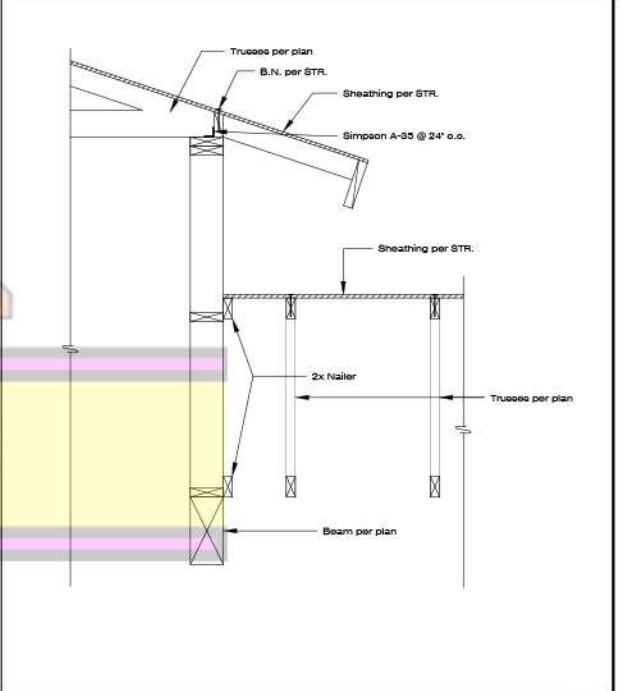

BEAM & ROOFS DETAIL

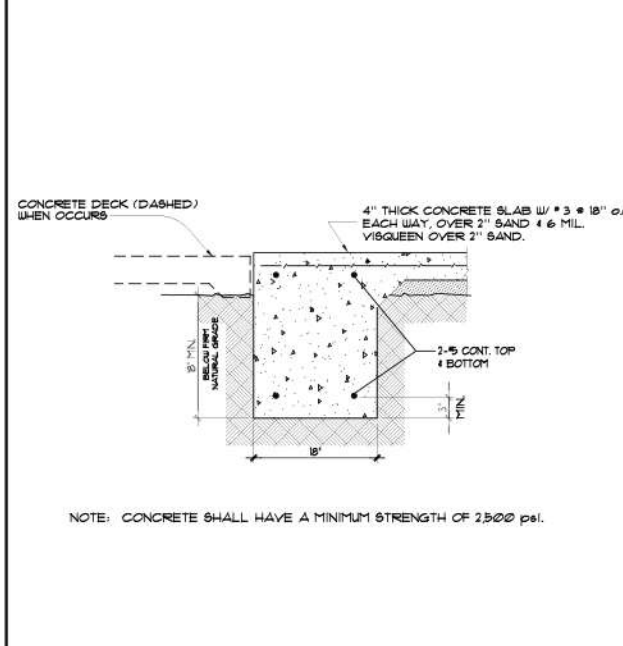

FOOTING AT GARAGE DOOR

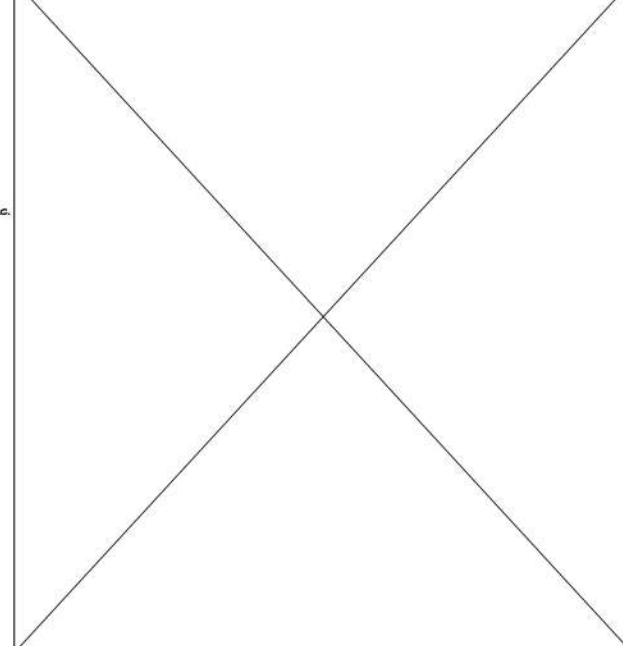

13

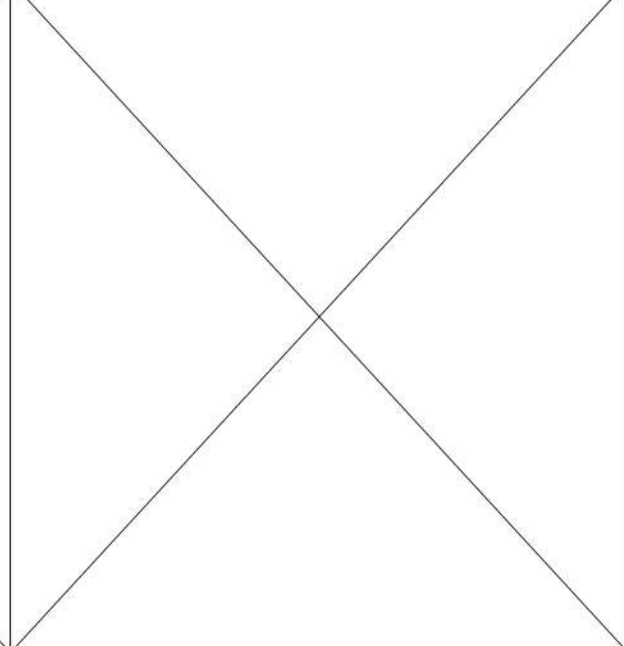

14

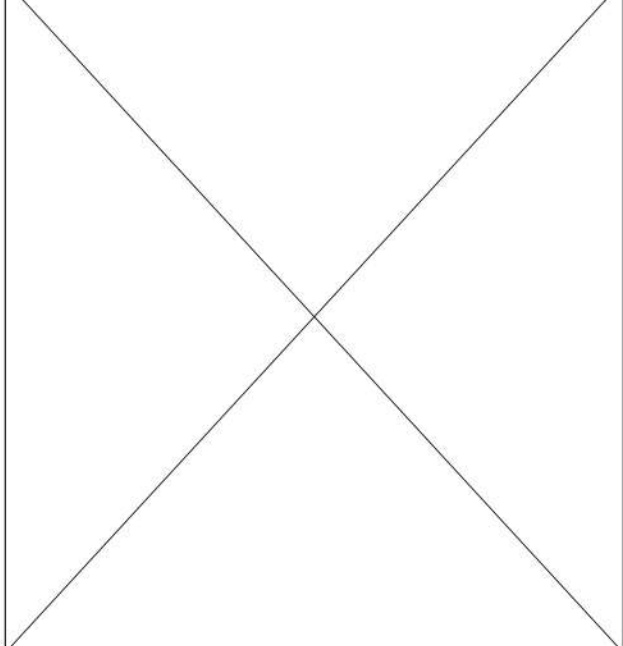

15

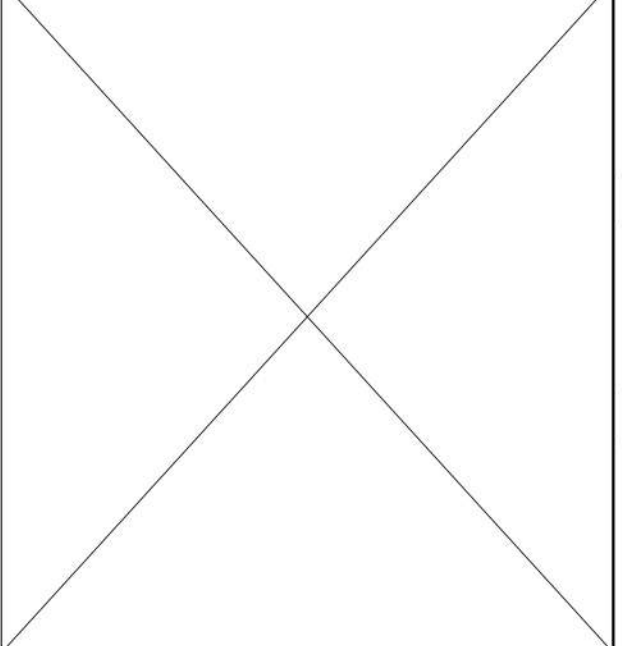

17

MAR-CO.
HOUSE PLANS & DESIGNS
PLANS-DRAFTING-DESIGN-BUILDING PERMITS
MARCO A. LAUREANO
760-805-2358
WWW.MARCOHOUSEPLANS.COM

MARCO A. LAUREANO
HOUSE PLANS & DESIGNS
PLANS-DRAFTING-DESIGN-BUILDING PERMITS
MARCO A. LAUREANO
760-805-2358
WWW.MARCOHOUSEPLANS.COM

PROJECT NAME & ADDRESS:
MATES' NEW RV & BOAT GARAGE
XXXX RYAN DR. ESCONDIDO, CA. 92025

CONSULTANT:

REVISIONS:

DATE: 09/25/2014
SCALE: AS SPECIFIED
DRAWN & PREPARED BY: MARCO A. LAUREANO
SHEET: D-1-R
OF: 11